

漏孔标定系统

Standard Leak Calibration System



FC-80 系列 Series

【特点】

- ➊ 压力变化分辨率达1Pa
- ➋ 气路设计独特，最大限度地消除了环境的影响
- ➌ 检测时间大幅缩短
- ➍ 置信概率95%的扩展不确定度可达5%
- ➎ 检测范围可达 可达 $5 \times 10^{-8} \sim 5 \times 10^{-4} \text{Pa} \cdot \text{m}^3/\text{s}$

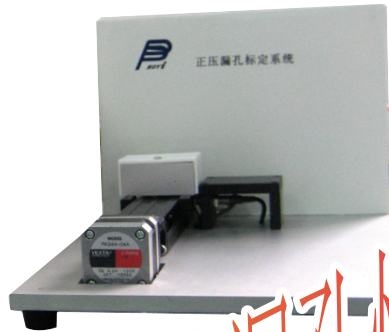

解决标准漏孔快速测试!!
Conduct FAST Detection for Standard Leak!!



【FEATURES】

- ➊ The pressure change resolution reaches to 1Pa
- ➋ Unique circuit design uttermostly eliminates the environmental impact
- ➌ Massively reduce the test time
- ➍ When confidence probability obtains 95%, the expanded uncertainty can reach to 5%
- ➎ The detection range can reach to $5 \times 10^{-8} \sim 5 \times 10^{-5} \text{Pa} \cdot \text{m}^3/\text{s}$

全新气路设计，硬件系统最大限度地消除了环境的影响!!

New pneumatic circuit, and hardware system uttermostly eliminate the influence of temperature and other environmental factors!!

主机 Main Body

控制仪器动作
Control the instruments actions

可与计算机通讯，直接打印测试报告
Communicate with computer and print the test report directly

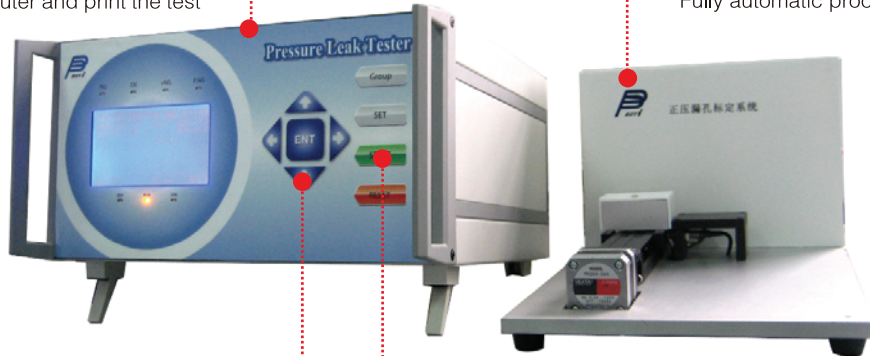

执行系统 Execution System

体积变化最小可达0.02mm³
The minimum volume change reaches to 0.02mm³

全自动机构，无需人员干涉
Fully automatic process without operator interference

设定键 Setting Key

各种参数设定
Set varied parameters

START开始键 Start Key

一键式操作，打破原有方式对检测人员的高技术要求
One key type operation avoids high technical requirements by operators

■ 全图形显示 Full Graphic Display

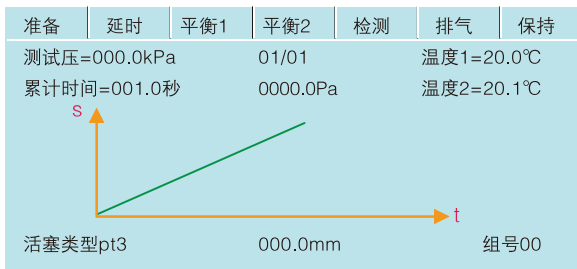

■ 测试时间短 Short Test Time

漏孔量级 Standard Leak Magnitude	测试时间 Testing Time
10 ⁻⁵ Pa.m ³ /s	<5min
10 ⁻⁶ Pa.m ³ /s	<18min
10 ⁻⁷ Pa.m ³ /s	<35min
10 ⁻⁸ Pa.m ³ /s	<35min

■ 重复性 Repeatability

次数5 Time5

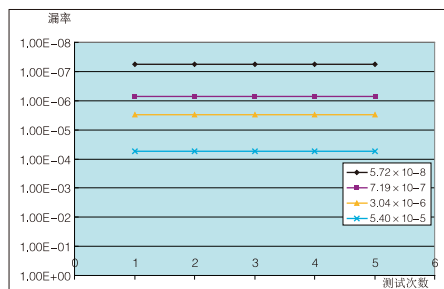

对同一漏孔连续测试五次的数值如上图所示
Conduct continuous five times detections for the same standard leak, and the numerical picture is as above.

■ 温度影响 Temperature Effect

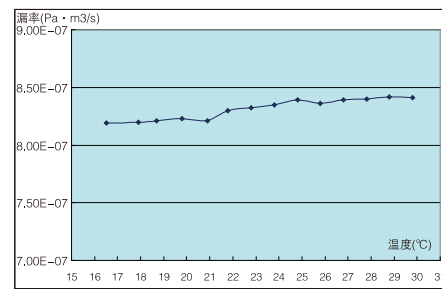

环境温度在16~30℃变化时，10⁻⁷量级漏孔漏率随温度的变化如上图，如果除去漏孔本身受温度影响的数据，标定器几乎不受温度影响。

The above graphic describe how the leak rate (10⁻⁷ magnitude) varies with the change of the temperature, when the ambient temperature is between 16℃ and 30℃.

The temperature nearly puts no influence on the calibrator, if ignore the influences of the standard leak itself caused by temperature

■ 测试范围 Measuring Range

型号 Model	m/s	10 ⁻⁸	10 ⁻⁷	10 ⁻⁶	10 ⁻⁵	10 ⁻⁴	10 ⁻³
FC-80口-1			5X10 ⁻⁸			5X10 ⁻⁵	
FC-80口-2					1X10 ⁻⁵		5X10 ⁻⁴

■ 选型 Model Selection

① 压力范围 Pressure Range

记号 Mode	漏孔压力 Standard Leak Pressure	备注 Remark
P	正压 Positive Pressure	漏孔入口压力为任意正压，出口为大气压 Inlet Pressure can be any positive pressure and outlet pressure is barometric pressure.
V	真空 Vacuum Pressure	漏孔入口压力为大气，出口为负压或真空 Inlet Pressure is barometric pressure and outlet pressure is negative pressure or vacuum pressure.

② 漏率范围 Leak Rate Range

记号 Mode	测量范围 Measuring Range
1	$5 \times 10^{-8} \sim 5 \times 10^{-5} \text{Pa.m}^3/\text{s}$
2	$1 \times 10^{-5} \sim 5 \times 10^{-4} \text{Pa.m}^3/\text{s}$

■ 规格 Specifications

型号 Model	FC-80P	FC-80V
适用对象 Applications	正压漏孔 Positive-pressure standard leak	负压或真空漏孔 negative-pressure standard leak or vacuum standard leak
测试方式 Testing Method	恒压变容法 Constant pressure& transfiguration method	
漏孔压力范围 Pressure Range	入口压力为任意正压，出口为大气压 Inlet pressure: Any positive pressure Outlet pressure: Barometric Pressure	入口压力为大气，出口为负压或真空 Inlet pressure: Barometric Pressure Outlet pressure: Negative pressure or vacuum
漏率范围 Leak Rate Range	$5 \times 10^{-8} \sim 5 \times 10^{-5} \text{Pa.m}^3/\text{s}$	$1 \times 10^{-5} \sim 5 \times 10^{-4} \text{Pa.m}^3/\text{s}$
气体种类 Gas Type	洁净干燥的空气，氮气，氦气，R134，等 Dry clean air, Nitrogen, Helium, R134, etc	
测试不确定度 Testing indeterminacy	$1 \times 10^{-6} \text{Pa.m}^3/\text{s} \sim 5 \times 10^{-4} \text{Pa.m}^3/\text{s} < 5\%$	$5 \times 10^{-7} \sim 5 \times 10^{-5} \text{Pa.m}^3/\text{s} < 5\%$ $5 \times 10^{-8} \sim 1 \times 10^{-7} \text{Pa.m}^3/\text{s} < 10\%$
变容室压力变化分辨率 Pressure resolution ratio of transfiguration chamber	1Pa	
测试压单位 Testing Pressure Unit	kPa, MPa, Psi, bar, mbar, Torr	
测试结果单位 Test Result Unit	$\text{Pa.m}^3/\text{s}$, mL/min, atm.mL/s, mbar.L/s, Torr.L/s	
数据通讯方式 Data Communication Method	多种模式的RS232 Varied method based on RS232	
温度/湿度范围 Temperature / humidity range	仪器使用温度：(无结露) Operating temperature: (Without precipitation) 0~50℃, 45~85%PH 标准要求测试温度 Standard Required Operating temperature: $23 \pm 7^\circ\text{C}$	
电源 Power Supply	AC 100 ~ 240V, 50/60Hz	
功耗 Power Consumption	< 50W	
重量 Weight	主机 6.5kg ; 执行系统 12kg Main Body: 6.5kg Execution System: 12kg	
语言 Language	中文/英语 Chinese / English	

■外形尺寸 (图) Dimensions

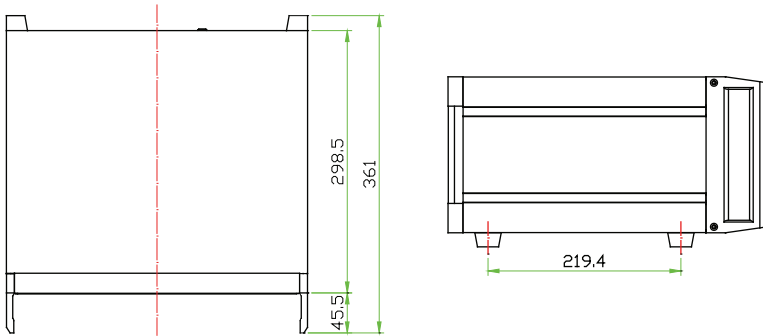
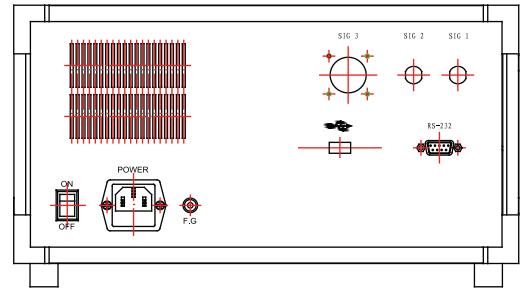
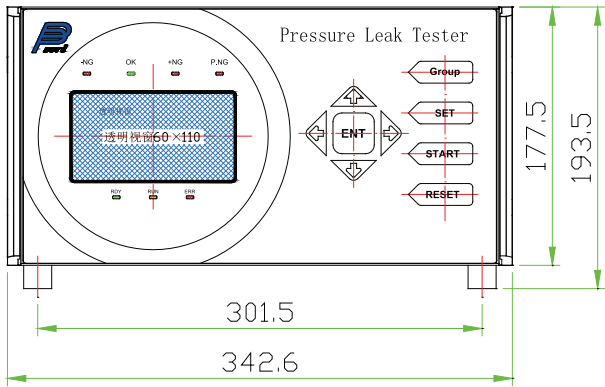

【主机】Main Body

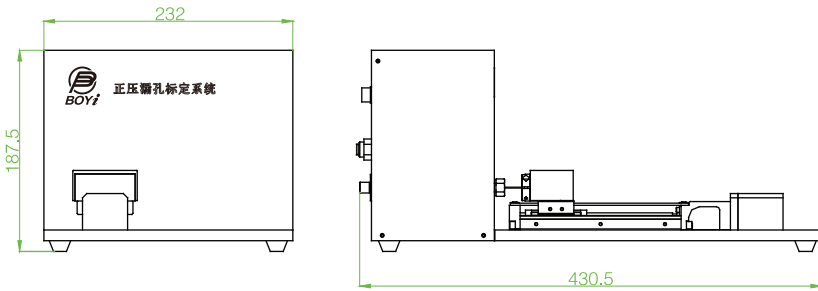

【执行系统】Execution System

主要产品 ● 气密检漏仪 ● 数字压力表 ● 流量计 ● 自动压力、流量控制器 ● 密封性能检测专用设备

 **天津博益气动股份有限公司**
TIANJIN BOYI PNEUMATICS CO., LTD.



代理经销商

公司·工厂: 天津开发区第九大街80号丰华工业园7号厂区 邮编: 300457
电话: (86)22-59810966 传真: (86)22-59810963
营销中心: 北京市丰台区角门18号名流未来大厦801-805室 邮编: 100068
电话: (86)10-87582461 传真: (86)10-87582462
网址: www.boyiqd.com 邮箱: sales@boyiqd.com



扫一扫, 查看
办事处地址

公司在广州、顺德、杭州、上海、苏州、长沙、武汉、重庆、西安、济南、沈阳设有分支机构。

C-BY-000FC80-X-04
Printed in China